

Bauanleitung für „Bahnhof Benediktbeuern“, Nr. 3520
Instructions for "Country station", No. 3520
Instructions d'assemblage pour «Gare», No. 3520
Bouwbeschrijving voor „Station Benediktbeuern“, No. 3520
Instrucciones de montaje para «Estación», No. 3520
Istruzione per la costruzione «Stazione Benediktbeuern», No. 3520

Bitte legen Sie die Einzelteile nach Buchstabengruppen zusammen und beginnen Sie dann den Zeichnungen entsprechend mit dem Zusammenbau.

Arrange the individual parts by letter groups, and then begin assembling in accordance with the drawings.

Pour l'assemblage, il faut suivre l'ordre alphabétique des dessins, et dans chaque dessin l'ordre numérique des pièces.

De onderdelen volgens lettergroepen indelen en overeenkomstig de afbeeldingen monteren.

Ordenar las piezas por el orden de las letras indicadas para empezar con el montaje siguiendo el croquis.

Prego mettere insieme i pezzi singoli secondo gruppi alfabetici, poi cominciare il montaggio corrispondente ai disegni.

Inhalt/Contents/Contenu/Inhoud

24417 = 4 x	28655 = 1 x	28695 = 1 x	28735 = 1 x	28760 = 4 x	28789 = 1 x
24855 = 2 x	28656 = 1 x	28696 = 1 x	28737 = 2 x	28761 = 2 x	28790 = 1 x
25344 = 15 x	28663 = 1 x	28697 = 1 x	28738 = 1 x	28762 = 2 x	28791 = 1 x
25984 = 1 x	28664 = 2 x	28698 = 1 x	28739 = 1 x	28763 = 1 x	28792 = 1 x
26301 = 1 x	28665 = 1 x	28699 = 1 x	28740 = 3 x	28765 = 1 x	28793 = 2 x
26624 = 10 x	28666 = 2 x	28700 = 2 x	28741 = 1 x	28766 = 1 x	28795 = 1 x
26779 = 5 x	28668 = 1 x	28702 = 1 x	28742 = 1 x	28767 = 2 x	28796 = 1 x
26801 = 1 x	28669 = 1 x	28716 = 2 x	28744 = 1 x	28768 = 1 x	28797 = 4 x
26802 = 4 x	28670 = 1 x	28720 = 4 x	28745 = 1 x	28769 = 4 x	28798 = 2 x
27115 = 1 x	28671 = 2 x	28721 = 1 x	28746 = 1 x	28770 = 4 x	28799 = 1 x
27582 = 4 x	28672 = 2 x	28722 = 2 x	28747 = 1 x	28771 = 4 x	28800 = 2 x
28635 = 1 x	28673 = 4 x	28723 = 4 x	28748 = 1 x	28772 = 2 x	28801 = 1 x
28637 = 4 x	28677 = 1 x	28724 = 2 x	28749 = 1 x	28773 = 2 x	28802 = 1 x
28638 = 15 x	28682 = 7 x	28725 = 1 x	28750 = 1 x	28774 = 1 x	28803 = 4 x
28639 = 10 x	28683 = 1 x	28727 = 1 x	28751 = 2 x	28775 = 1 x	28804 = 1 x
28640 = 1 x	28684 = 3 x	28728 = 1 x	28752 = 2 x	28776 = 2 x	28805 = 1 x
28642 = 1 x	28686 = 2 x	28729 = 1 x	28753 = 4 x	28777 = 1 x	28949 = 1 x
28643 = 2 x	28687 = 4 x	28730 = 1 x	28754 = 2 x	28778 = 2 x	
28644 = 1 x	28688 = 3 x	28731 = 1 x	28755 = 2 x	28785 = 1 x	
28652 = 1 x	28689 = 2 x	28732 = 1 x	28756 = 1 x	28786 = 1 x	
28653 = 1 x	28690 = 3 x	28733 = 1 x	28758 = 1 x	28787 = 1 x	
28654 = 1 x	28691 = 2 x	28734 = 1 x	28759 = 1 x	28788 = 1 x	

Unsere Erzeugnisse entsprechen den Sicherheitsanforderungen an Spielzeug und dürfen deshalb das Verbandszeichen

DIN tragen.

Wir verwenden den recyclefähigen Kunststoff Polystyrol



Zum Erwerb dieses **VOLLMER**-Bausatzes gratulieren wir Ihnen. Sie haben beim Zusammenfügen bestimmt viel Freude, weil alles paßt und somit keine Nacharbeit erforderlich ist.

Ein erstklassiger Kunststoff-Kleber gehört dazu, um jede Enttäuschung auszuschließen. (Ist nicht im Bausatz enthalten)

VOLLMER Superezement S 30 und Supranol 2000 – die giftfreien Superkleber – kleben sauber und verschweißen dauerhaft. Durch hohen Verzögerungseffekt wird vorzeitiges Austrocknen verhindert.

Superezement S 30 mit handlichem Pinselverschluss für großflächige Teile.

Supranol 2000 mit Feinkanüle für punktgenaues Arbeiten in der ergonomisch richtig geformten Flasche.

Irrtum und Änderungen vorbehalten.

Vollmer GmbH & Co. KG, Postfach 40 09 20, D-70409 Stuttgart



Printed in Germany – Imprimé en Allemagne
 Gedrukt in Duitsland

(A)

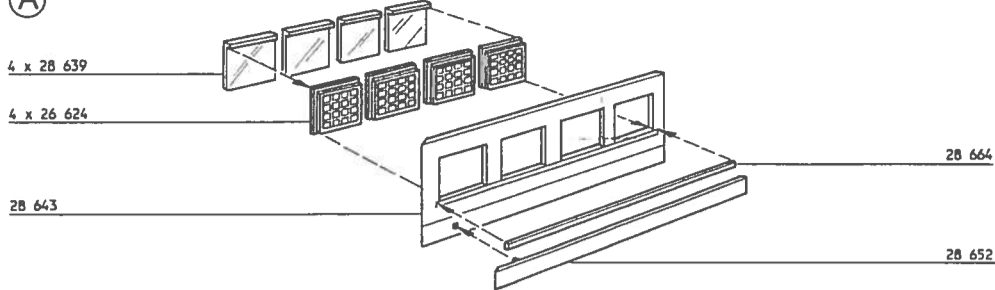

(B)

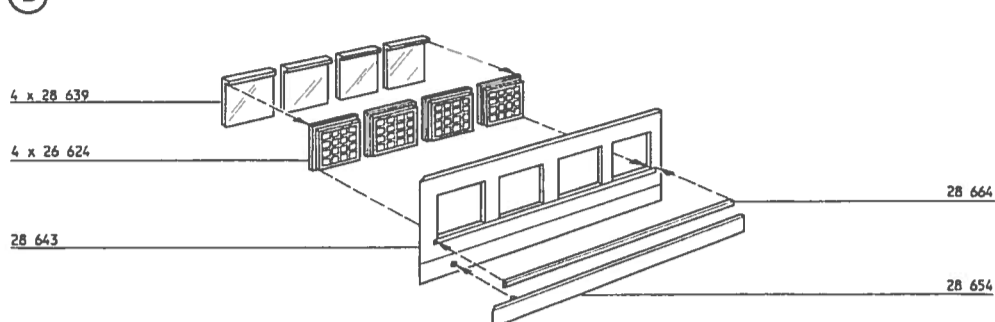

(C)

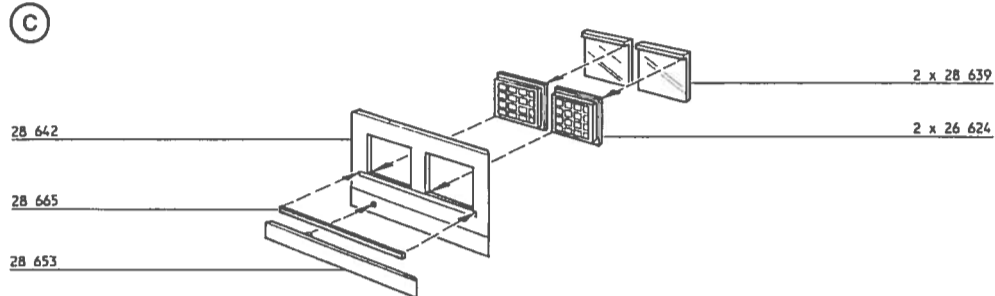

(D)

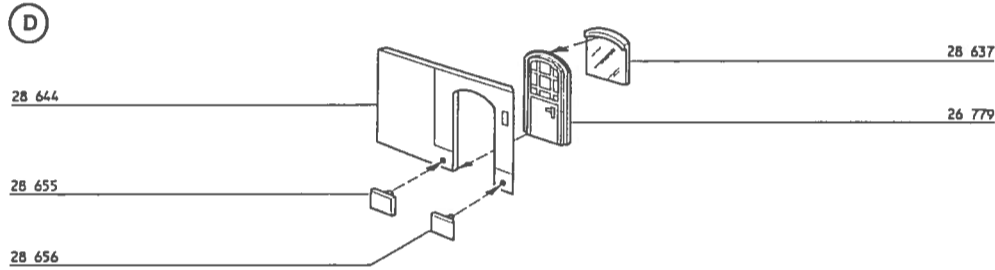

2

(E)

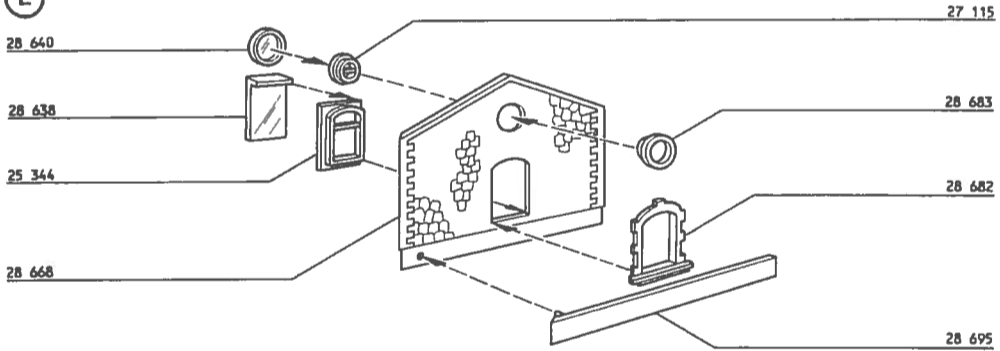

(F)

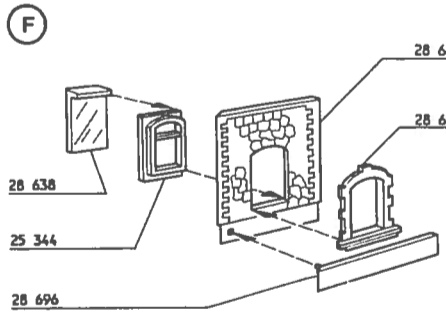

(G)

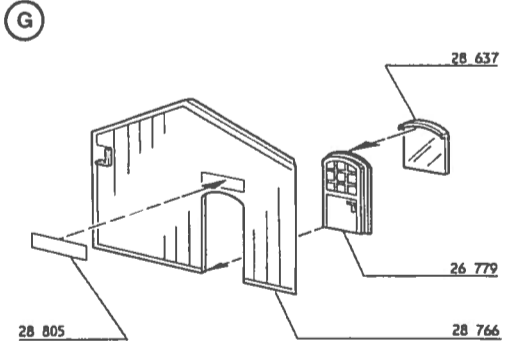

(H)

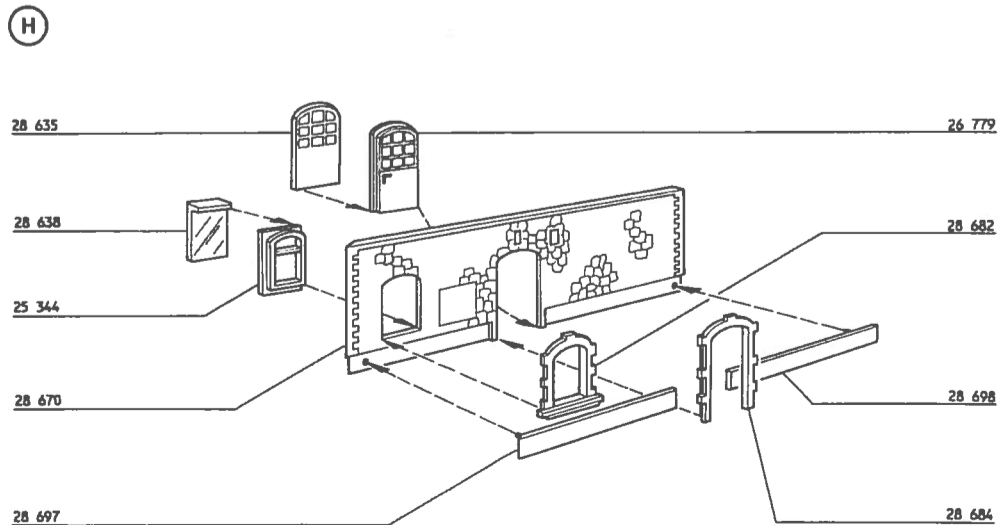

3

(I)

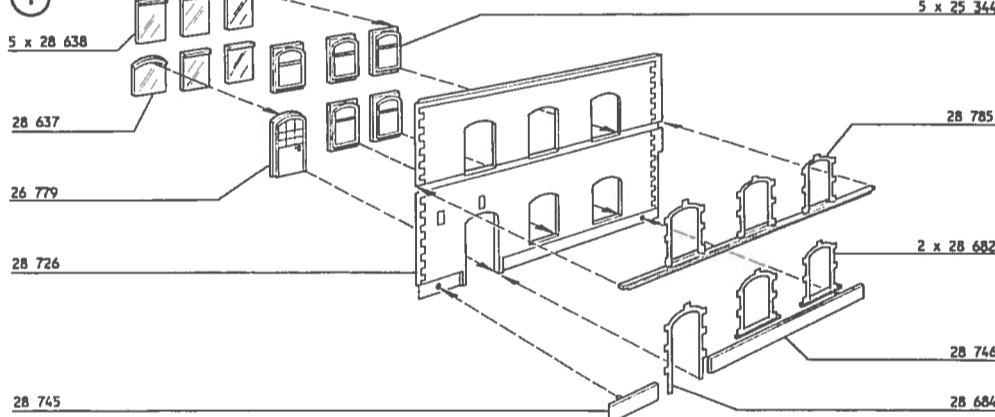

(J)

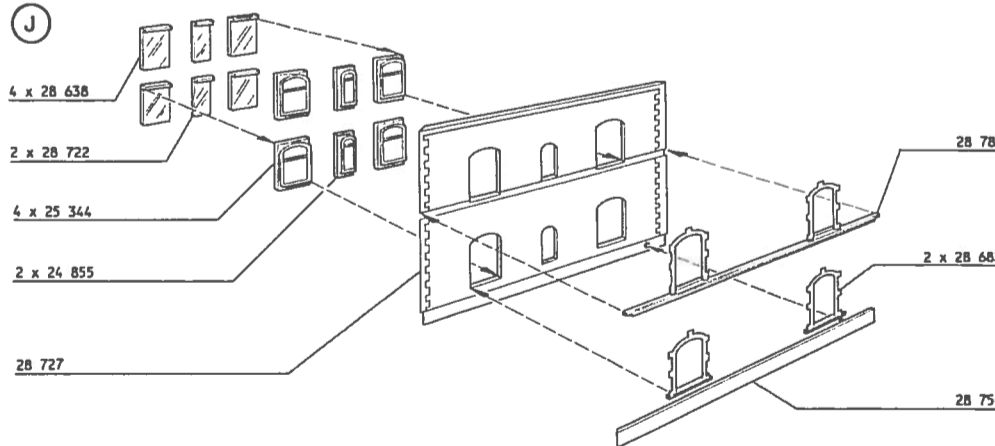

(K)

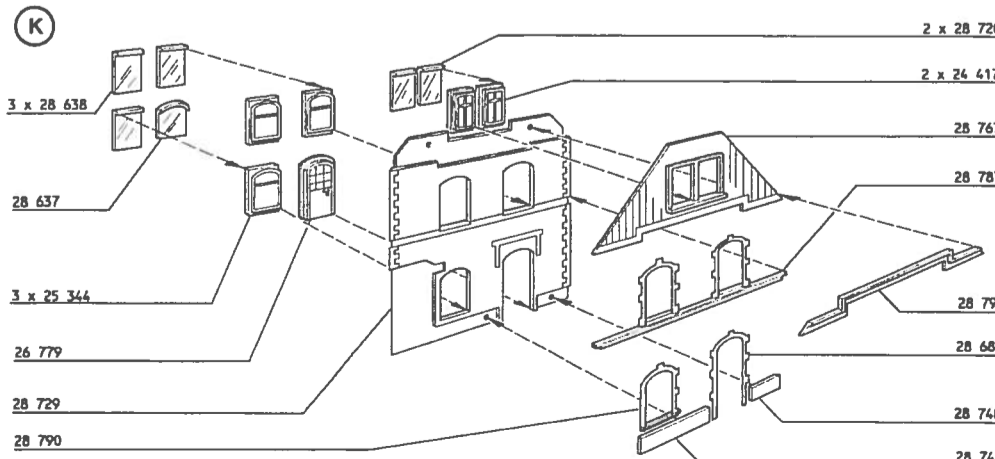

4

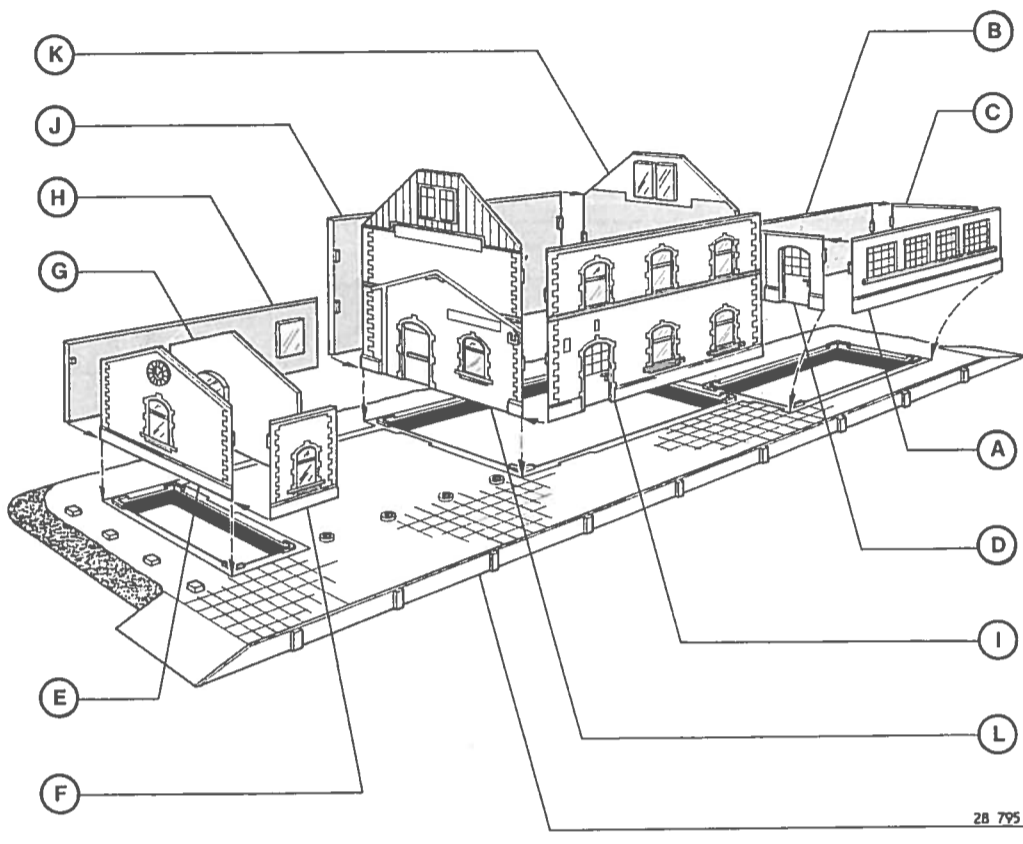
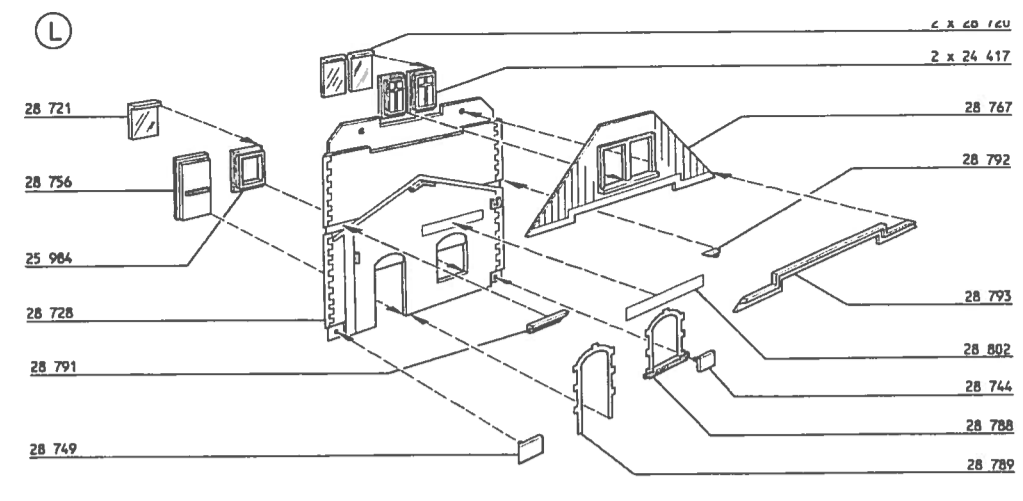

5

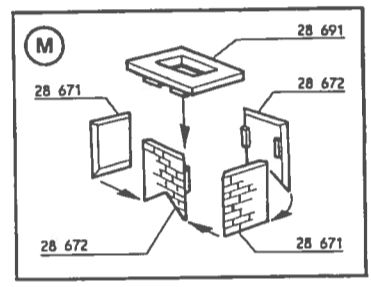
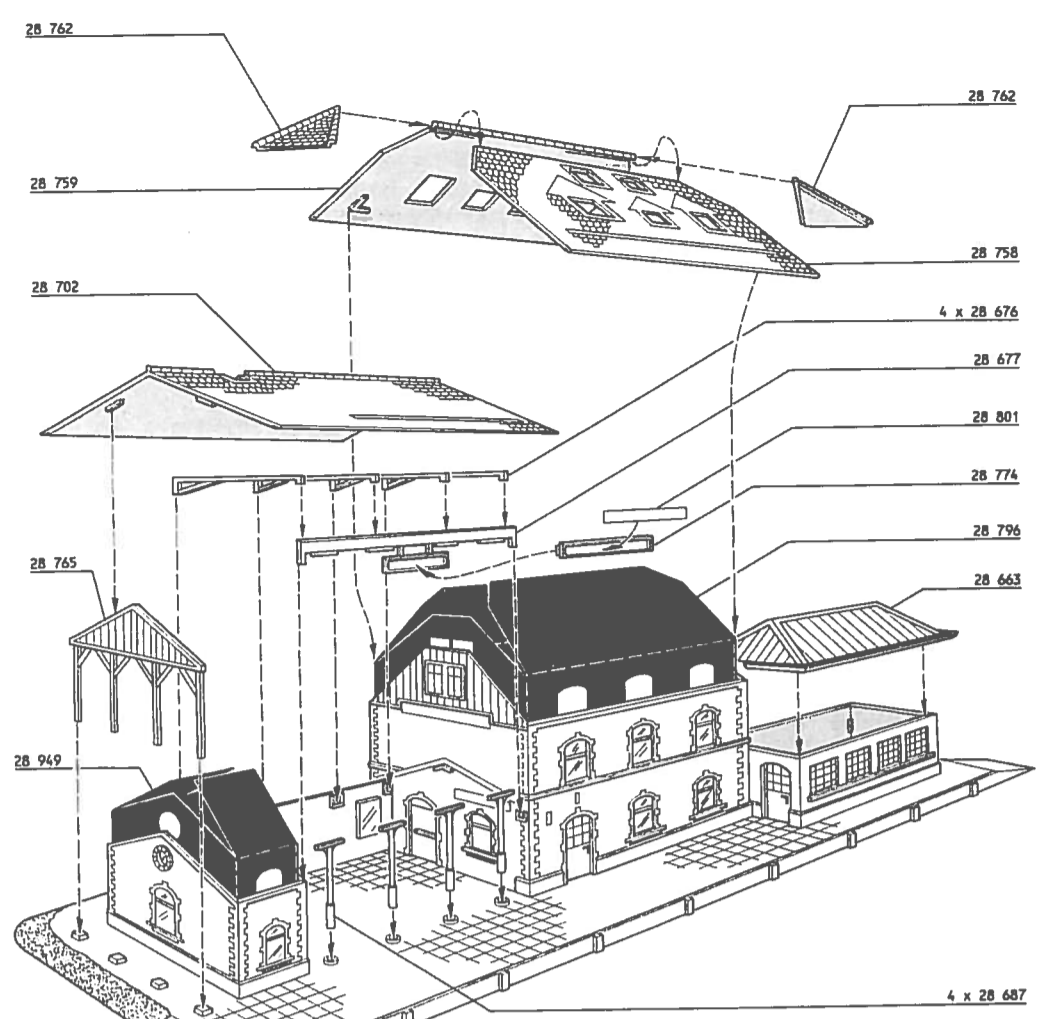

6

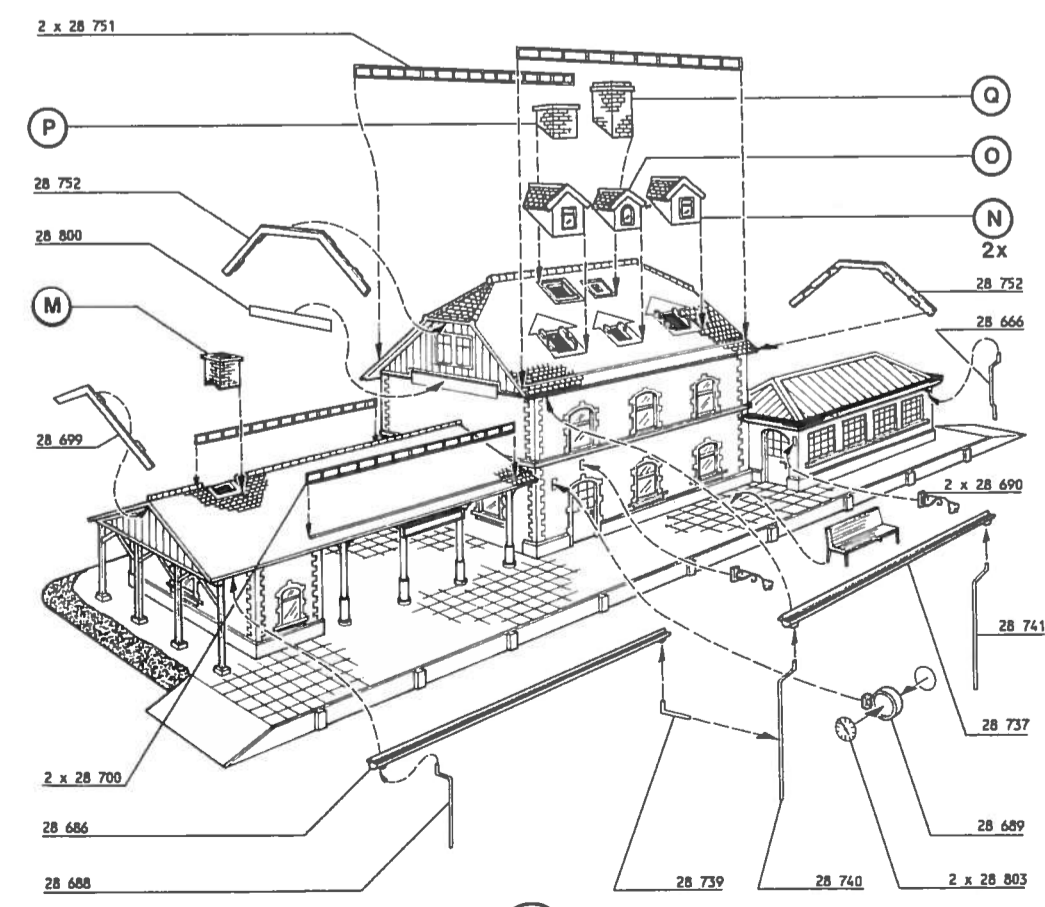
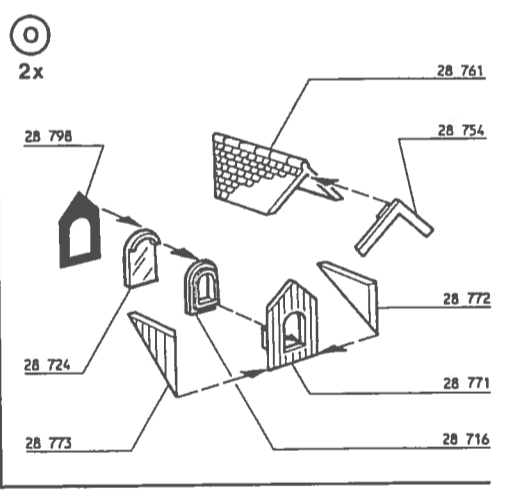
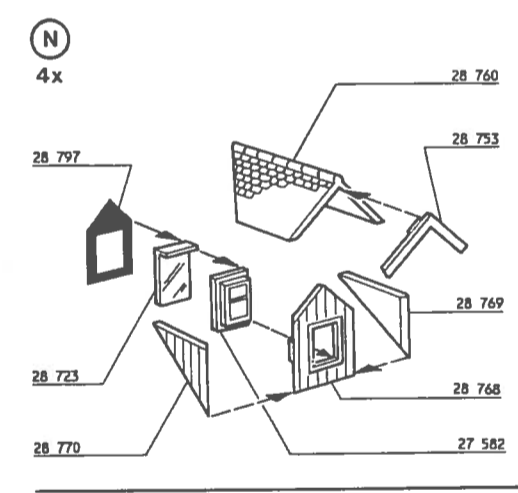
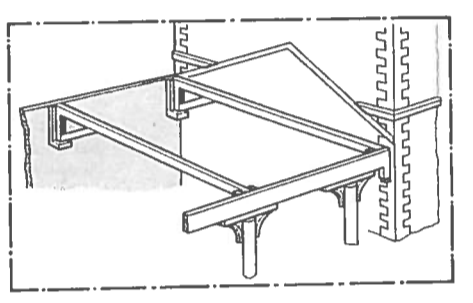

7

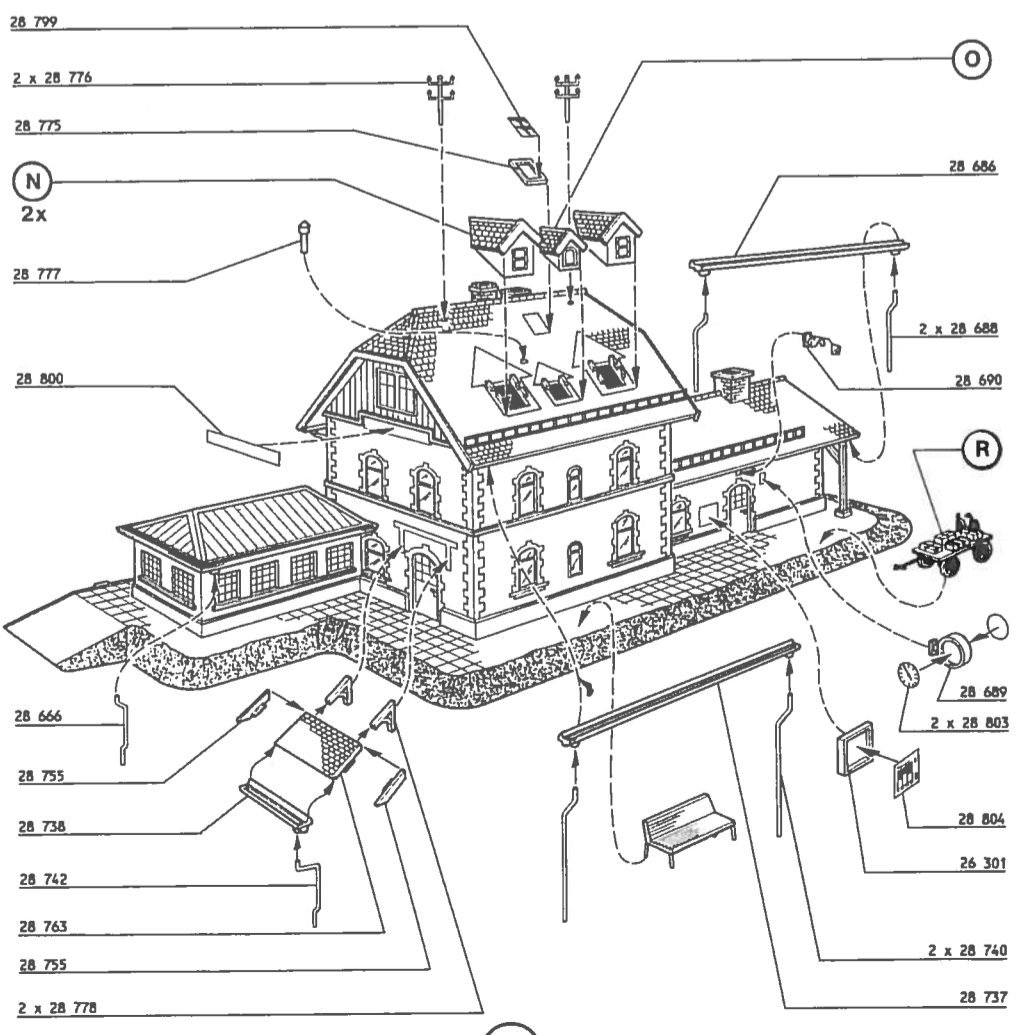
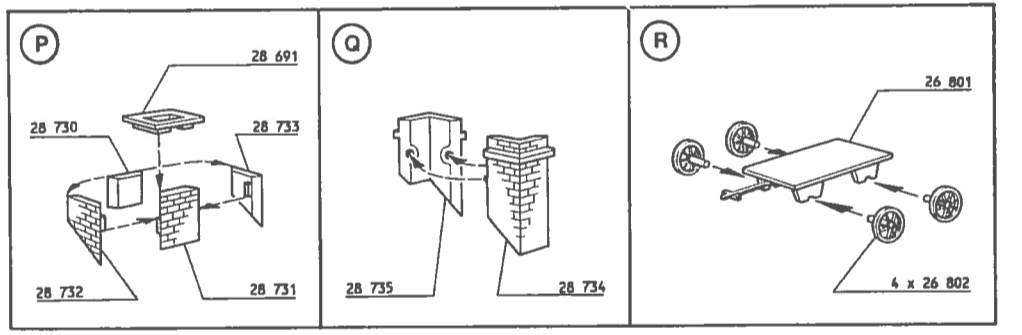

8